



Good Packaging
Better Packaging
Kraft Packaging

Packaging machines with
innovative power, precision
and reliability

Without us, it would be just a machine

With more than 200 years of company history, G. Kraft Maschinenbau GmbH as an owner-operated medium-sized company has become an important international manufacturer of special-purpose machines.

Our goal is to meet the changing requirements and demands of our customers in a flexible way and to further increase the confidence in our consistent quality. “Everything from a single source” is not an empty phrase for us, but it is lived every day. As a supplier of complete solutions, we strive to provide and develop new productivity advantages for our customers through automation.

Intelligent products, flexibility, competence, highest quality and short decision-making processes in the company are the foundation for permanent economic success and a strong future.



In the last 3 decades, individuality requirements, fast information and sales channels have led to a situation where production workflow, demands significantly more flexibility. A great number of varieties up to customized production are en vogue today. With our technology, our customers can package their products manufactured in this way efficiently and according to CE-requirements. Our KRAFT VPS100 cardboard cutting machine presents our central technology.



Sustainable thinking and efficient packaging

We attach great importance on conserving our resources and cover about 40% of our own electricity consumption with our own solar technology. When designing our cardboard cutting machines, the latest generation of drive technology is used and in the construction, we largely work without any pneumatics.

Our machines are therefore extremely energy efficient. The modern waste optimization ensures an optimal utilization of the available cardboard materials/ fanfold bale widths. Additionally, the machine is highly flexible and efficient. Thus, packaging and process costs are considerably reduced and as a side effect, environmental protection is significantly improved.



Our Kraft Eco Benefits

- + Energy-saving
- + Efficient
- + Resource-saving
- + Without pneumatics

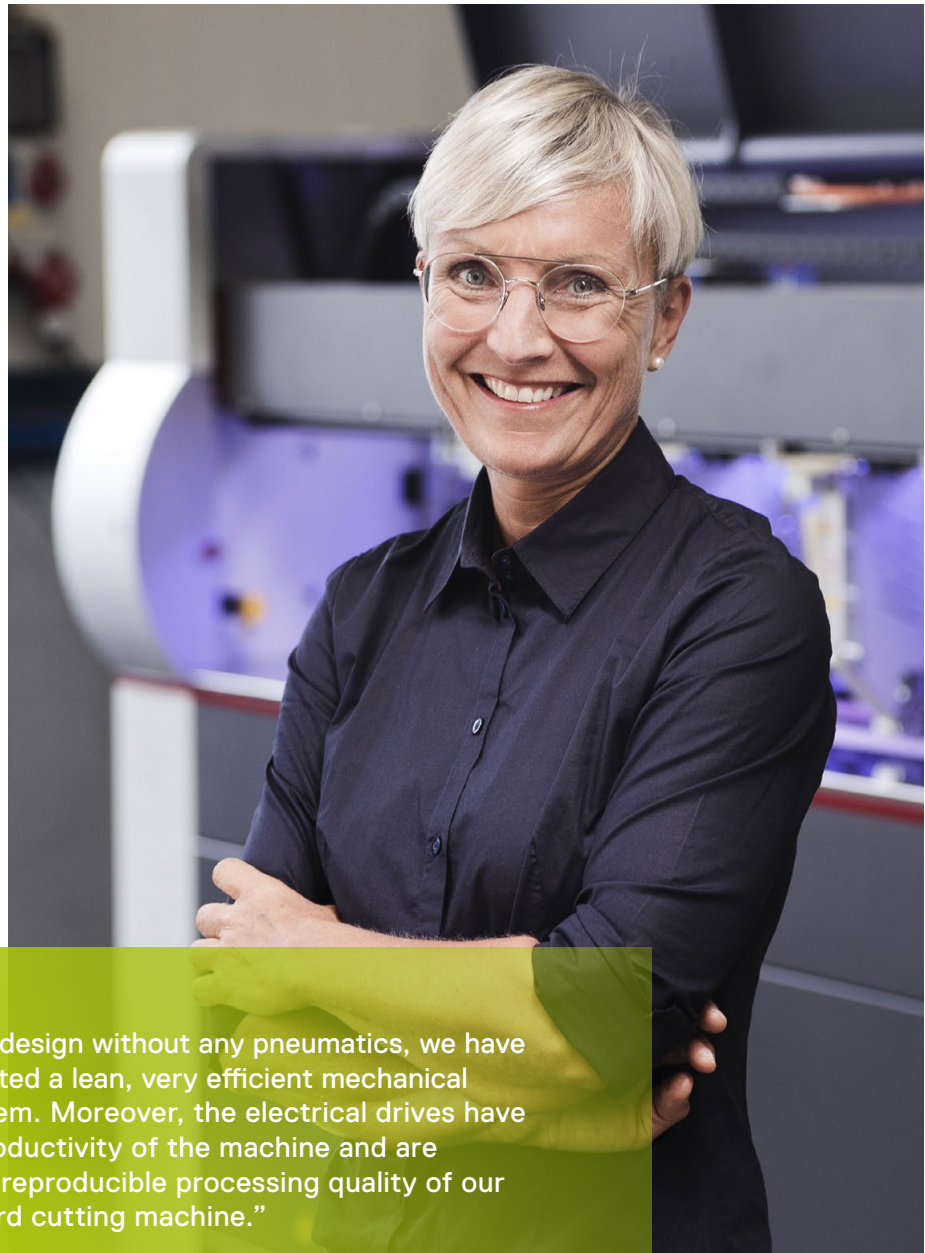

“By our machine design without any pneumatics, we have successfully created a lean, very efficient mechanical engineering system. Moreover, the electrical drives have increased the productivity of the machine and are the basis for the reproducible processing quality of our VPS100 cardboard cutting machine.”



The heart of the VPS100

The multi-purpose tool

The multi-purpose tool sets new standards in terms of performance and processing quality. In accordance with the single-point principle, cuts, perforations and creases are carried out on a processing roller. This provides flexibility and creates accessibility.

Positioning Motor

for a quick change of the tools

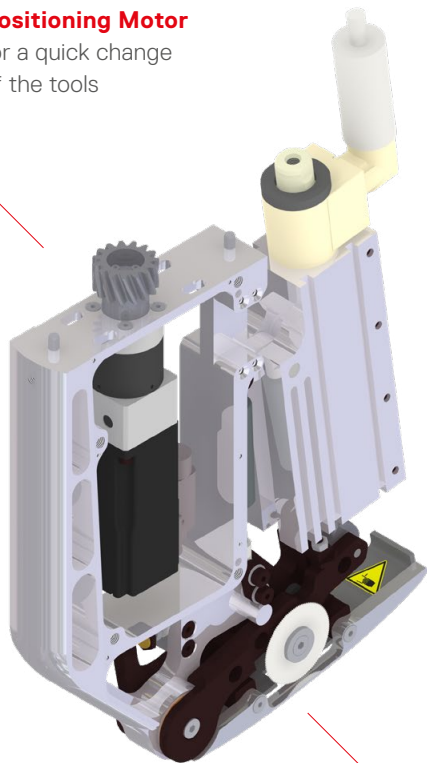

Linear drive

for free programming of the perforation intensity

Single-point principle

for creasing, cutting, perforating, scoring

Material-friendly grooving rail

for gentle processing

Your benefits:

- + Material-friendly creasing skid.
- + Free programming of perforation intensity
- + Short perforation cuts thanks to linear technology
- + Fast tool change by servo drive

Flexible and extendable

The optimal configuration for every application

The modular design of the KRAFT VPS100 cardboard cutting machines allows an individual configuration of your machine, thus efficiently adjusting the investment volume to the requirements. Proven and tested technology is used, regardless of the application.

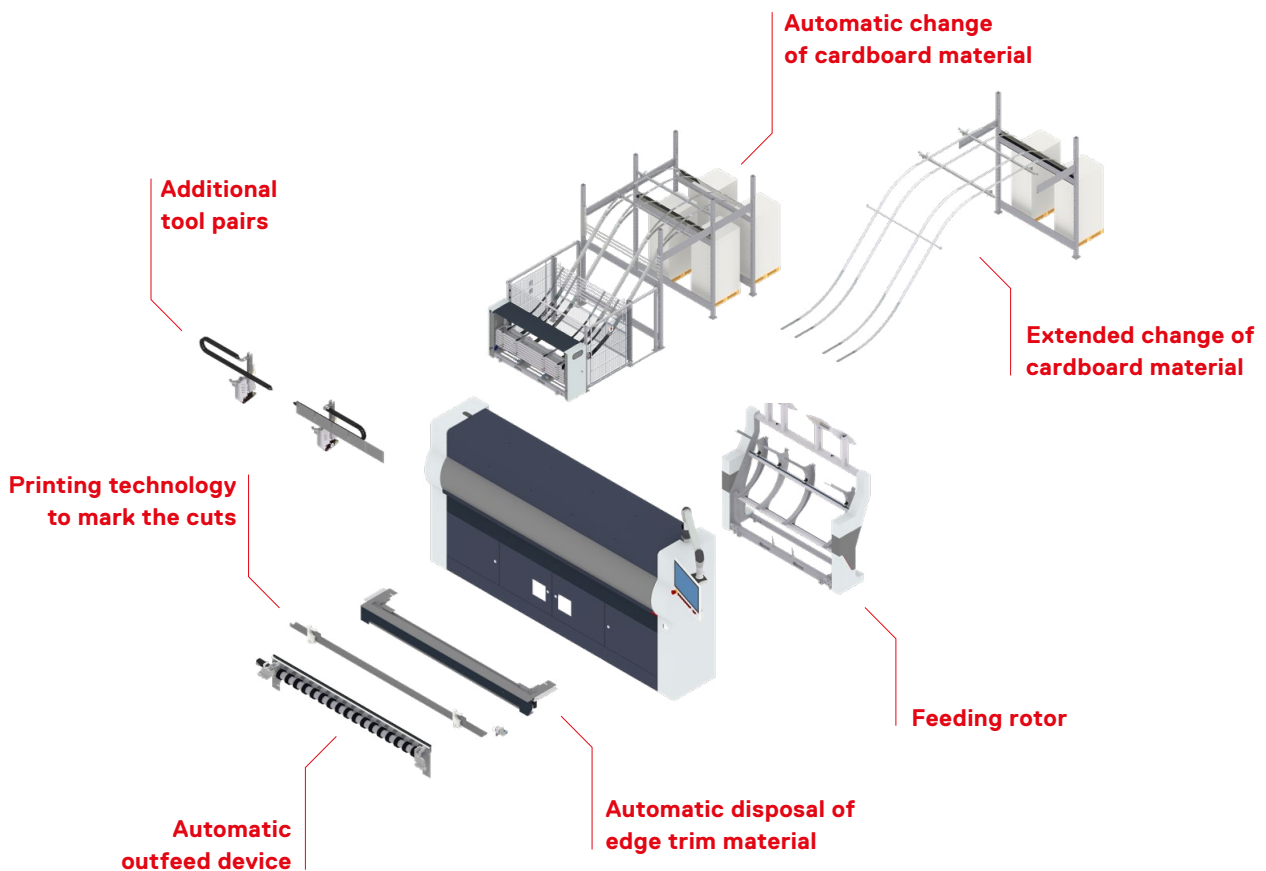

Your benefits:

- + Application-oriented
- + Highest quality
- + Retrofittable
- + Interchangeable

Intuitively and quickly reaching the goal

The user interface of the VPS100

The new user interface is optimally designed for input via touch screen. Clearly structured areas and graphical presentations allow easy inputs and provide clear feedback to the operator. The multi-stage waste optimization and the dynamic tool management run automatically in the background and ensure that maximum performance is reached with minimal waste. Product data from higher-level systems can be transferred to the production list. In addition, feedback to the higher-level system is possible.

Your benefits:

- + Intuitive user interface
- + Multi-stage waste optimization
- + Dynamic tool management
- + Three-level user administration





Just in time –
Precise
packaging for
every product

Individual instead
of pre-assembled

Optimal
use of your
storage space

1,500 → 2,500

Cardboard widths

7
2.5

Cardboard thickness

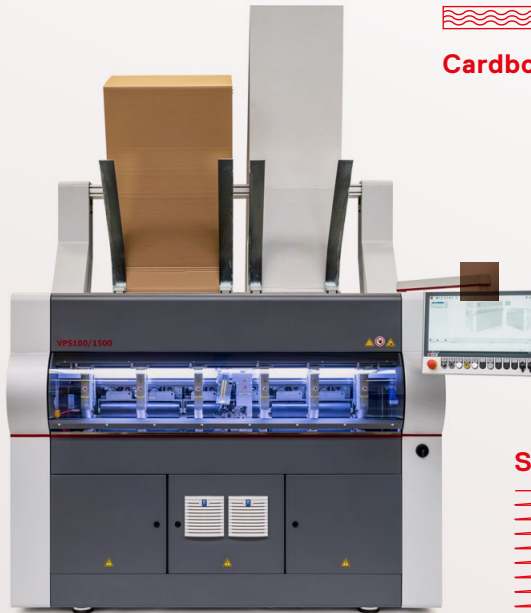

Stack height
2,200

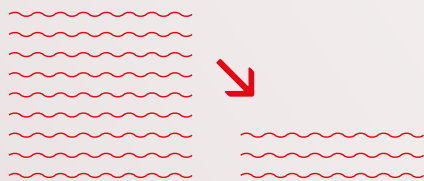

Less corrugated
cardboard is required



Significant
reduction
of filling material
and therefore
less waste

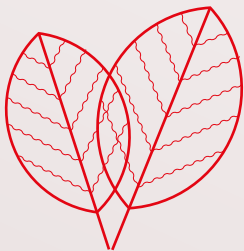

Corrugated
cardboard is

- Recyclable
- Renewable
- Natural
- ♦ **Sustainable**

Reduced delivery costs
and **less transport damage**
by precise packaging.

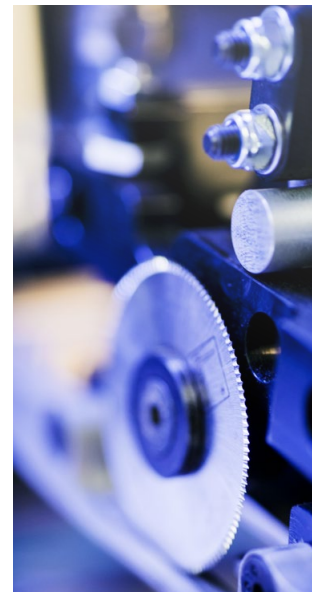

Always “On” and always available

KIP — KraftInformationPortal

If you log in at the machine, our KIP is, among other things, at your disposal. Here you find comprehensive information around the machine.

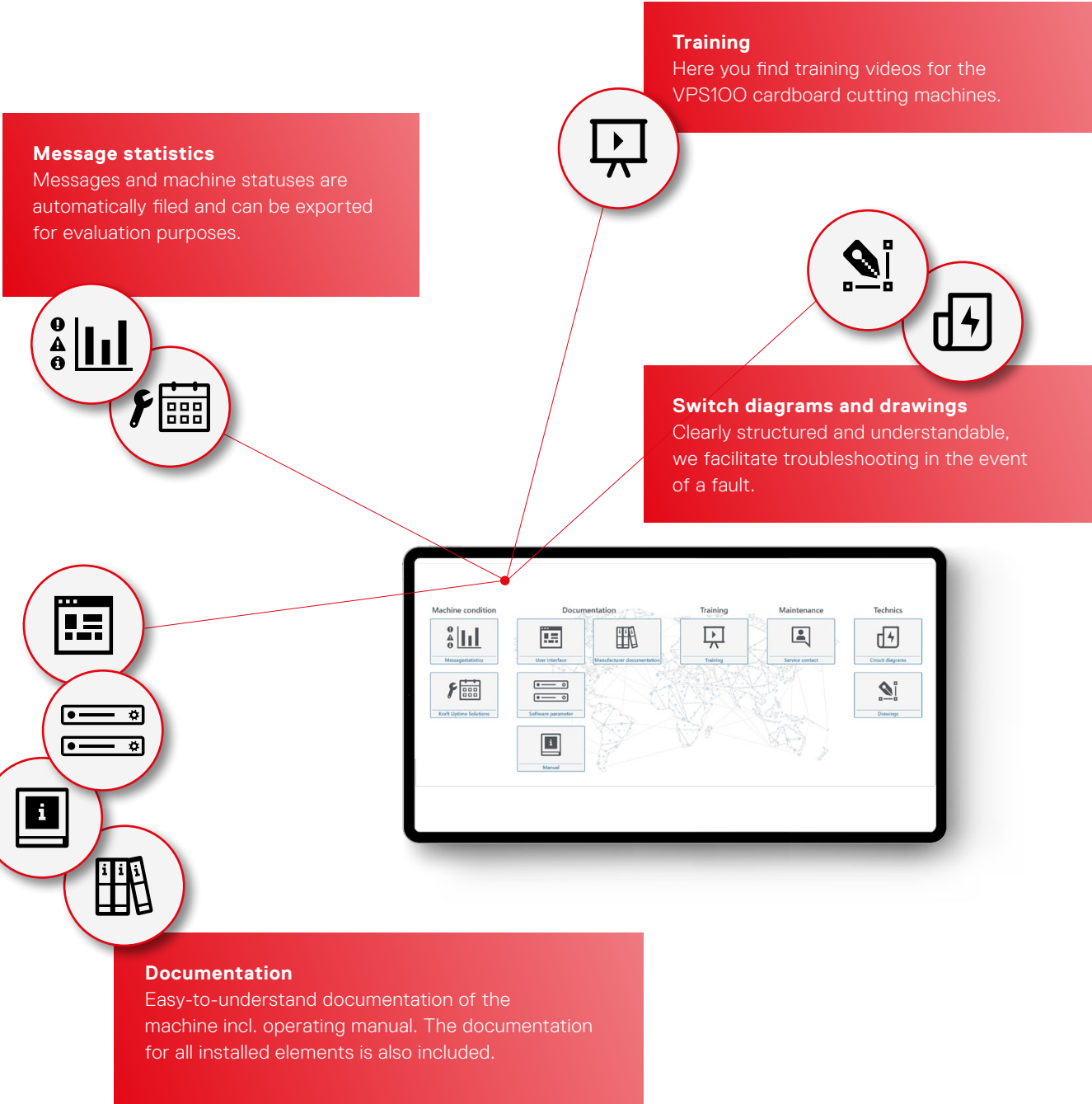

Quick and easy implementation of ideas

KBD — KraftBoxDesigner

With our KBD, parametric programming of packaging designs is quickly and easily provided. You can then adjust existing packaging elements or create your own packaging concepts at any time. In addition to length, width and height, your own variables can be created. Even calculations within a variable are possible.

The function of multi-piece packaging allows you to create packaging concepts consisting of more than just one cut. We ensure that your products are always packed optimally and according to your requirements.

Your benefits:

- + Incredibly simple handling
- + Free programming of packaging concepts
- + Creation of own variables
- + Multi-piece packaging

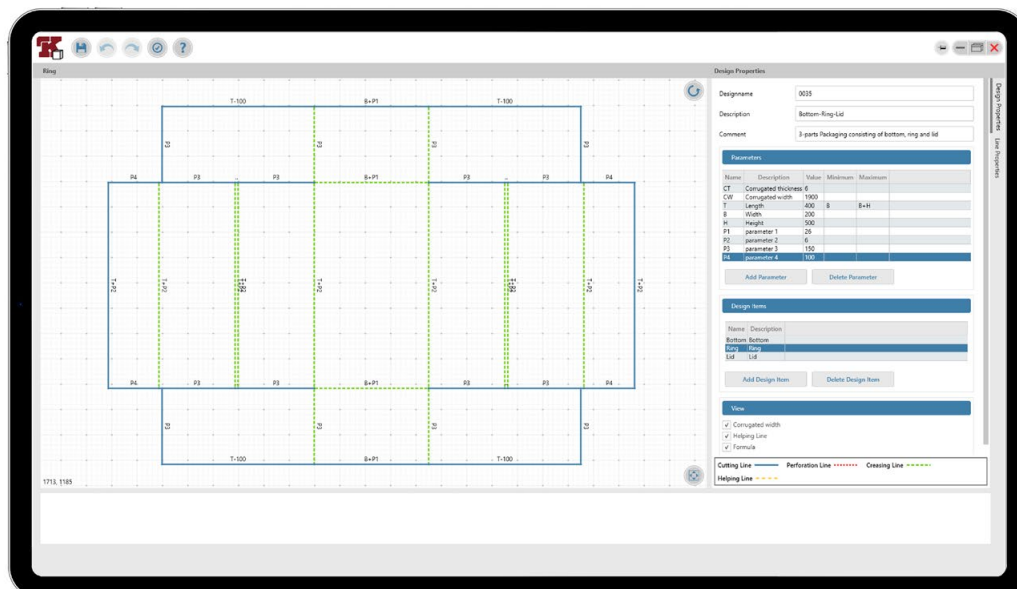

Everything from a single source

Plant engineering and process integration

Of course, our cardboard cutting machine is also integrated into our complex interlinked plants. For this purpose, the company Kraft supplies everything from a single source starting from the first up to the last process step and we meet your individual requirements.

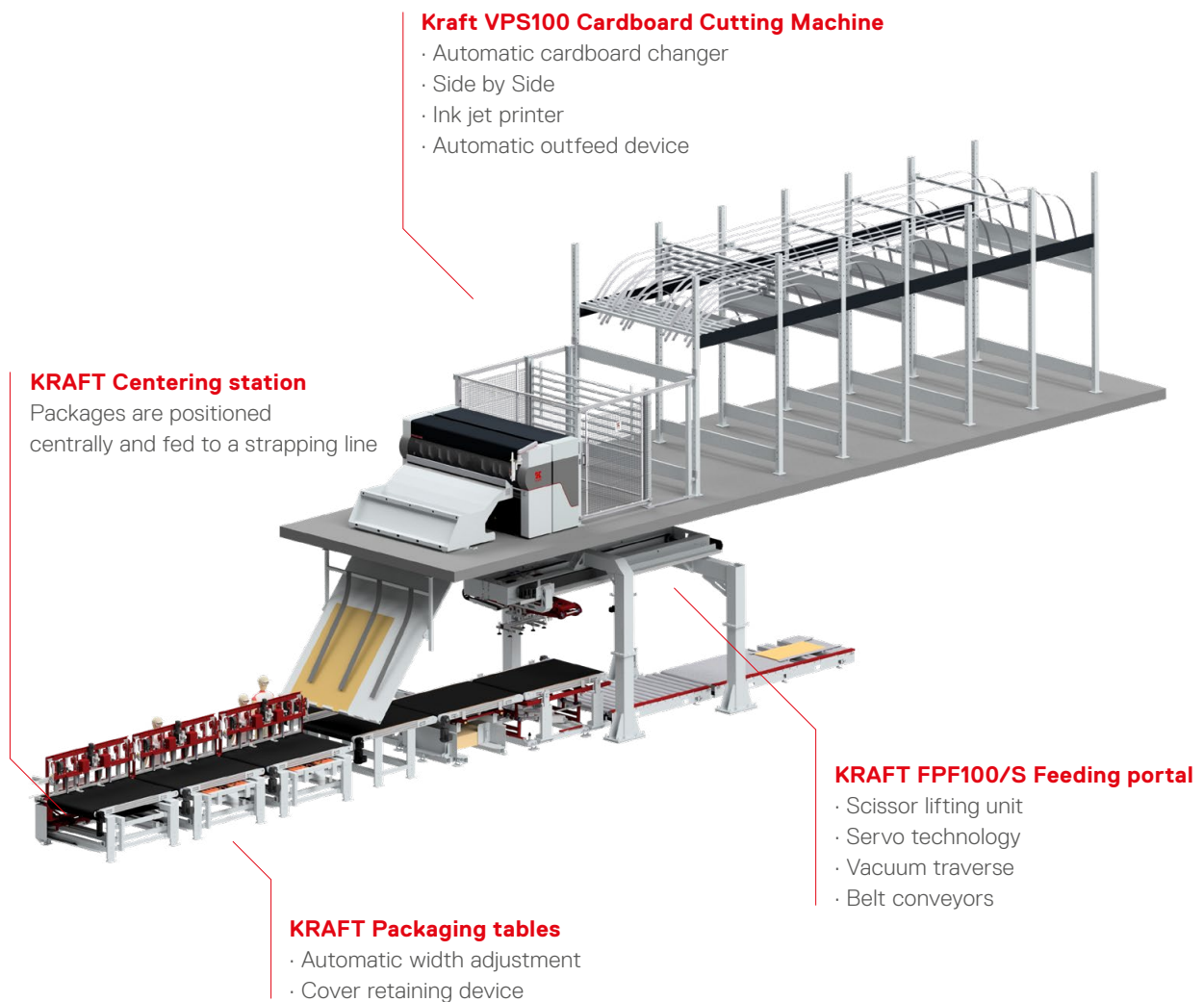

Your benefits:

- + Continuous from planning to realization
- + Integrated control
- + Line commissioning in our factory
- + Automation concepts

Our service for a sustainable partnership

Reliable and solution-oriented at your side

Sustainable investments require a sustainable partnership. From critical situations to preventive measures, we, as a machine supplier, become part of the customer organization and therefore must ensure that we are a reliable partner. We also see an extended task in the challenge to find improvement potentials in and around the machine and, if possible, to offer appropriate solutions. In the end, the success of our customers is the basis for our success.



Your benefits:

- + Our service hotline
Mon-Fri 6:00 a.m. – 10:00 p.m.
Sat 6:00 a.m. – 12:00 p.m.
- + Shipment of spare parts within 24 hours
- + Inspections and preventive maintenance
- + Training and courses for your employees

Technical data

Technical data	VPS 100/1500	VPS 100/2500
Cardboard width	1,500 mm	2,500 mm
Cardboard thickness	2.5 – 7.0 mm	2.5 – 7.0 mm
Longitudinal feed	max. 100 m/min	max. 100 m/min
Feed speed cross tool	150 m/min	150 m/min
Number of longitudinal tools	4 – 6 pcs	6 – 12 pcs
Number of chambers	max. 6	max. 6
Number of roll widths	max. 13	max. 13
Stack height	2,200 mm	2,200 mm

Subject to technical changes.

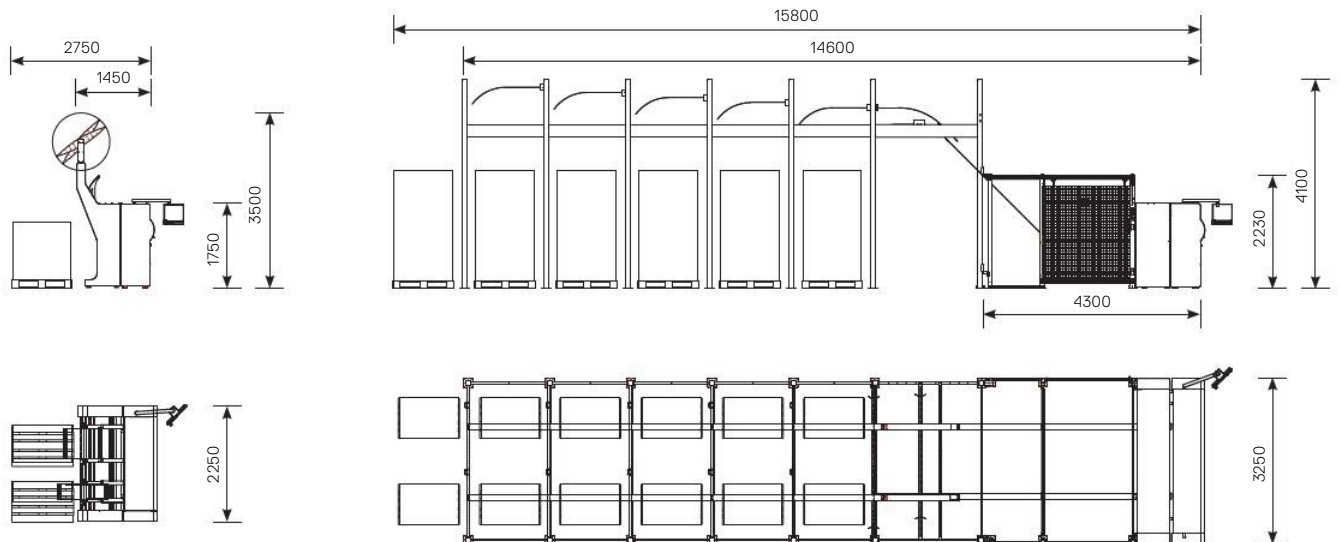



Our service hotline
+49 180 5804-150

Mon-Fri 6:00 a.m. – 10:00 p.m.
Sat 6:00 a.m. – 12:00 p.m.